

NO	DESCRIPTION	Q' TY	WT (kg)	REMARKS	NO	DESCRIPTION	Q' TY	WT (kg)	REMARKS	NO	DESCRIPTION	Q' TY	WT (kg)	REMARKS
001	COTTER PIN	1		∅3x20	013	U-NUT	1		M8	024	HEX BOLT	8		M12x45
002	PLAIN WASHER	1		M12	014	PLAIN ROLLER	2			025	ADJUST WASHER	16		
003	HAND WHEEL	1			A15	PLAIN SIDE PLATE ASS'Y	1			026	SIDE WASHER	1		
004	GUIDE PLATE	1			016	NAME PLATE	1			027	U NUT	1		M22
006	WRENCH BOLT S/W	2		M6x15	018	FIX BOLT	1		M8x75	028	HAND CHAIN	1		
A07	GEAR SIDE PLATE ASS'Y	1			019	BRACKET	2			029	PINION NUT	1		
008	BALL BEARING	4		6205ZZ	020	STAY	1			033	BUMPER RUBBER	4		
009	GEAR ROLLER	2			021	RING	2			034	BUMPER BRACKET	4		
010	SNAP RING	4		S-25	022	CENTER PLATE	1			035	HEX BOLT S/W	8		
012	PINION SHAFT	1			023	U NUT	8		M12	036	CONNECTOR ASS'Y	1		OPTION

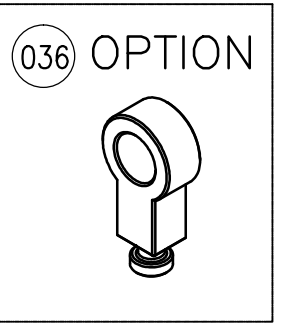
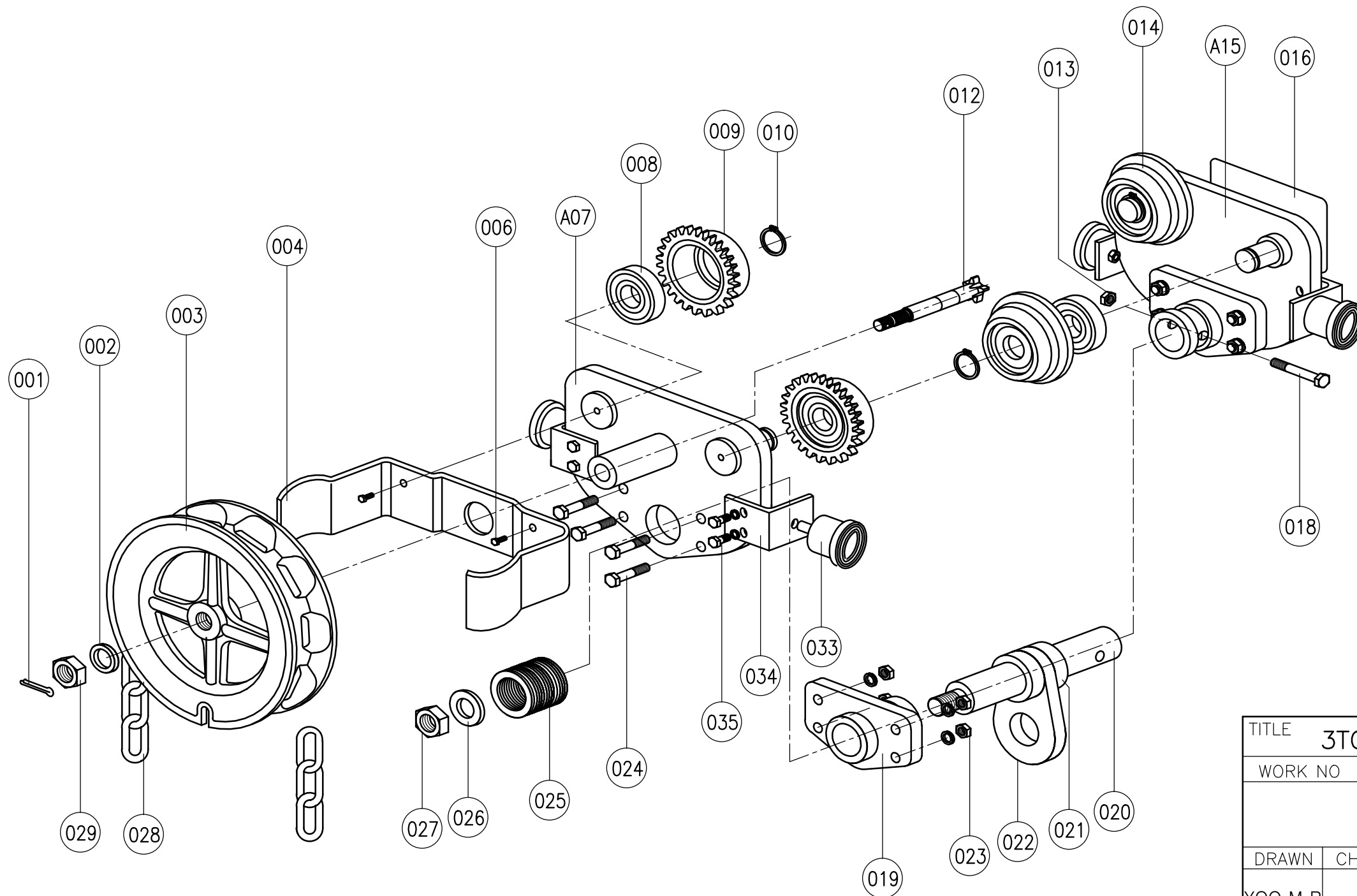

TITLE				3TON EX-GEAR TROLLEY		PROJECTION	
WORK NO				WORK NAME			
				SCALE		Q'TY	
				N S		1	
DRAWN	CHECKED	REVIEWED	APPROVED	DRAWING NO			
YOO.M.R	-	LEE. H.J	Y. K	DSG030EE01			
2013.01.03	-	2013.01.03	2013.01.03				
DAESAN INoTEC INC							