

NO	DESCRIPTION	MAT'L	Q'TY	WT(kg)	REMARKS

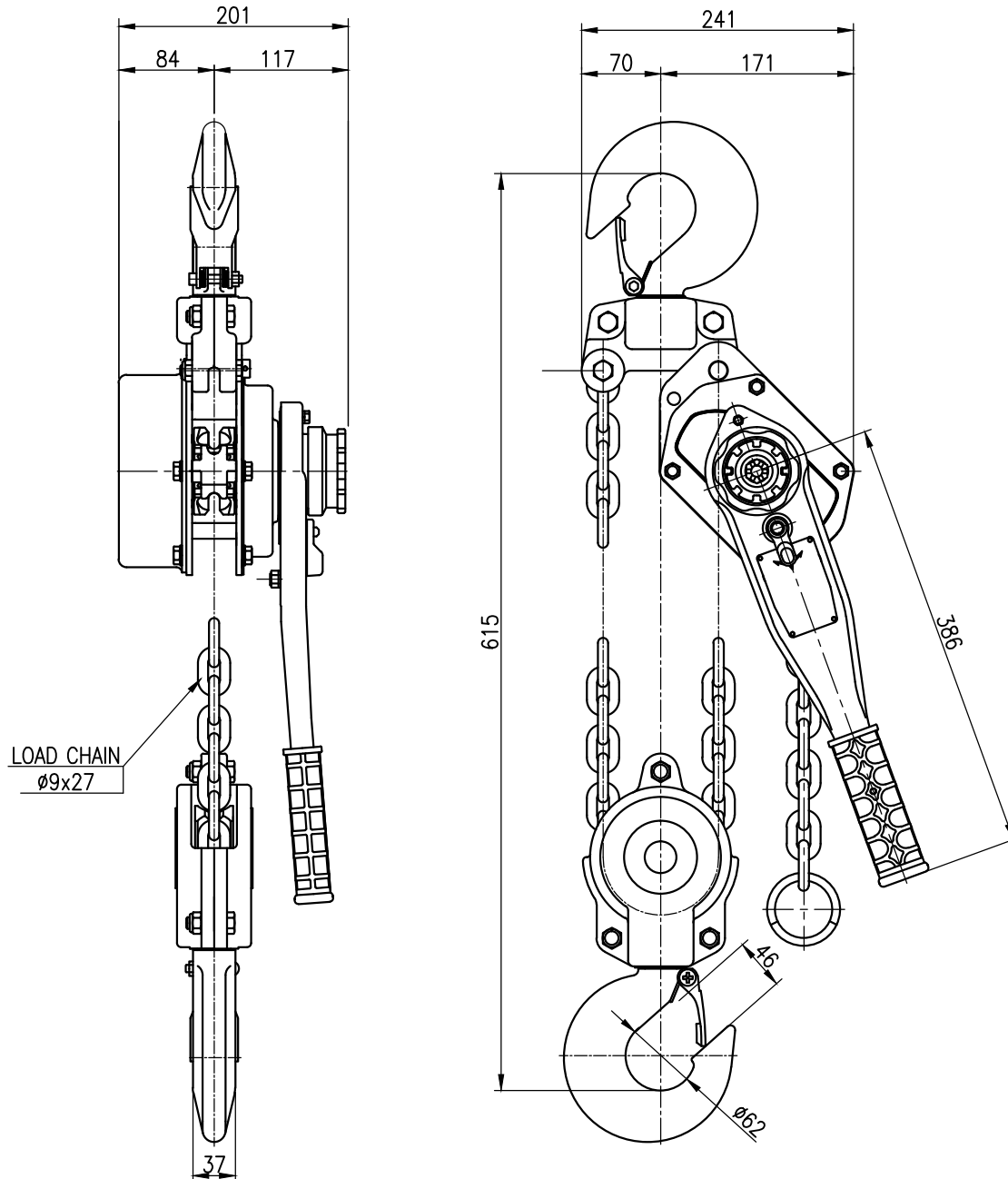

SPECIFICATION	
HOISTING LOAD	6.0 TON
TESTING LOAD	7.5 TON
LIFTING HEIGHT	1.5 M
HOISTING	MANUAL
WEIGHT	28.5 kg
LOAD CHAIN	ø9X27

TITLE				PROJECTION	
NDM-6TON LEVER BLOCK					
WORK NO		WORK NAME		SCALE	Q'TY
				1/2	1
DRAWN	CHECKED	REVIEWED	APPROVED	DRAWING NO	
KIM.S.H		LEE. H.J	Y.K	NDS060001	
2016.07.01		2016.07.01	2016.07.01		
DAESAN INoTEC INC					

REV.NO	DATE	REVISION DESCRIPTION	DRAWN	CHECKED	APPROVED